

# Gtech

## Premium Power Sweeper

Model number: SW20

**OPERATING MANUAL**

# IMPORTANT SAFEGUARDS:



**IMPORTANT: READ ALL INSTRUCTIONS BEFORE USE. RETAIN INSTRUCTIONS FOR FUTURE REFERENCE.**



Do not use in rain or leave outdoors whilst raining.



**WARNING:** Basic safety precautions should always be observed when using an electrical appliance, including the following to reduce the risk of fire, electrical shock, or injury:

## Personal Safety:

- Store indoors in a dry place out of the reach of children.
- Always use responsibly. This appliance can be used by children aged from 8 years and above and persons with reduced physical, sensory or mental capabilities or lack of experience and knowledge if they have been given supervision or instruction concerning use of the appliance in a safe way and understand the hazards involved.
- Don't let children play with the appliance; supervise children using or maintaining the appliance.
- Use only manufacturer's recommended attachments as described in this manual; misuse or use of any accessory or attachment other than those recommended, may present a risk of personal injury.
- Take extra care when cleaning stairs.
- Keep the appliance and accessories away from hot surfaces.
- Particularly keep hair away from openings and moving parts.

## Electrical safety:

- Only use batteries and chargers supplied by Gtech.
- Never modify the charger in any way.
- The charger must only be used for UK mains supply.  
A charger that is suitable for one type of battery pack may create a risk of fire when used with another battery pack; never use the charger with another appliance or attempt to charge this product with another charger.
- Before use, check the charger cord for signs of damage or ageing. A damaged or entangled charger cord increases the risk of fire and electric shock.
- Do not abuse the charger cord.
- Never carry the charger by the cord.
- Do not pull the cord to disconnect from a socket; grasp the plug and pull to disconnect.
- Don't wrap the cord around the charger when storing.
- Keep the charger cord away from hot surfaces and sharp edges.
- The supply cord cannot be replaced. If the cord is damaged the charger should be discarded and replaced.
- Do not handle the charger or the appliance with wet hands.

- Do not store or charge the appliance outdoors.
- Unplug the charger before removing the battery, cleaning or maintaining the appliance.

### **Battery safety:**

- This appliance includes NiMH batteries; **do not incinerate batteries or expose to high temperatures**, as they may explode.
- Liquid ejected from the battery may cause irritation or burns.
- In an emergency situation contact professional help immediately.
- Leaks from the battery cells can occur under extreme conditions. Do not touch any liquid that leaks from the battery. If the liquid gets on your skin wash immediately with soap and water. If the liquid gets into your eyes, flush them immediately with clean water for a minimum of 10 minutes and seek medical attention. Use gloves to dispose of the battery immediately in accordance with local regulations.
- Shorting the battery terminals may cause burns or fire.
- Store battery away from metal objects that could connect the terminals.
- When you dispose of the appliance remove the battery and dispose of the battery safely in accordance with local regulations.

### **Service:**

- Before using the appliance and after any impact, check for signs of wear or damage and repair as necessary.
- Do not use the appliance if any part is damaged or defective.
- Repairs should be carried out by a service agent or a suitably qualified person in accordance with relevant safety regulations. Repairs by unqualified persons could be dangerous.
- Never modify the appliance in any way as this may increase the risk of personal injury.
- Only use replacement parts or accessories provided or recommended by Gtech.

### **Intended use:**

- This appliance has been designed for domestic dry sweeping only.
- Do not use on wet surfaces.
- Do not pick up anything that is flammable, burning or smoking.
- Use only as described in this manual.
- Don't use on concrete, tarmac or other rough surfaces.

### **WARNING:**

- **Do not use water, solvents, or polishes to clean the outside of the appliance; wipe clean with a dry cloth.**
- **Never immerse the unit in water and do not clean in a dish washer.**

# Thank you for choosing a Gtech Power Sweeper

"I started Gtech to create sensible, easy to use products, which do a great job. Your opinion is important to us. Please take the time to write a review of the Sweeper either on the website of the store you bought it from or by emailing us at [support@greytechnology.co.uk](mailto:support@greytechnology.co.uk). We will use your feedback to improve our products and services and let other people know what it's like to be part of the Gtech family."

Nick Grey – Inventor, Owner of Gtech

Register your warranty now at:

[www.gtech.co.uk/warrantyregistration](http://www.gtech.co.uk/warrantyregistration) or call **08000 518353**

Keep your receipt with this manual. You will need it if you ever have a warranty claim.

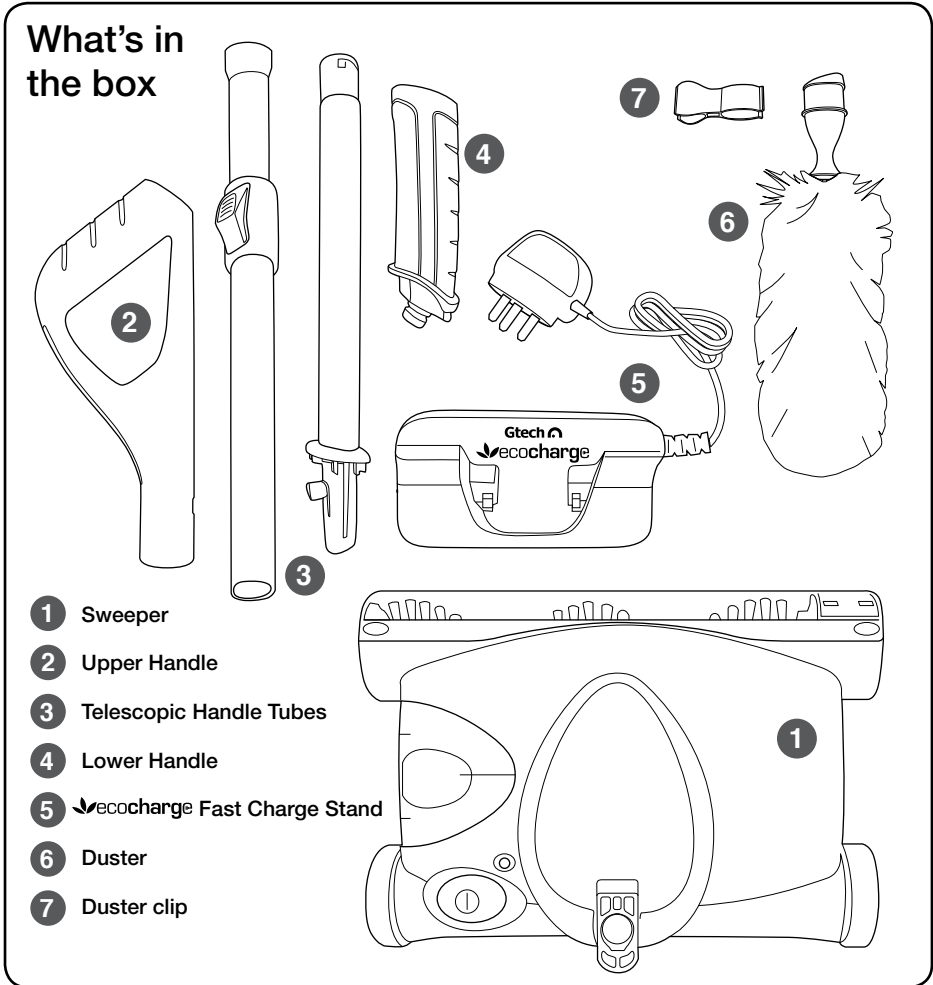

## Assembly

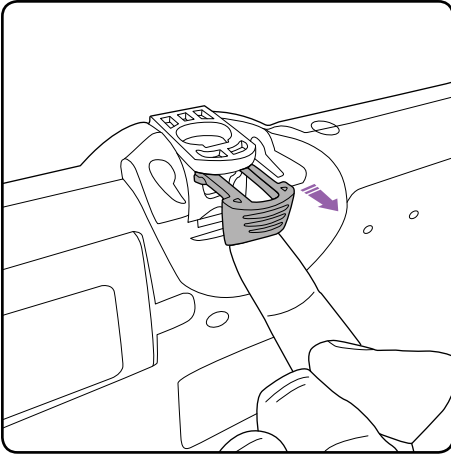

To assemble the lower handle  
Pull out the locking clip.

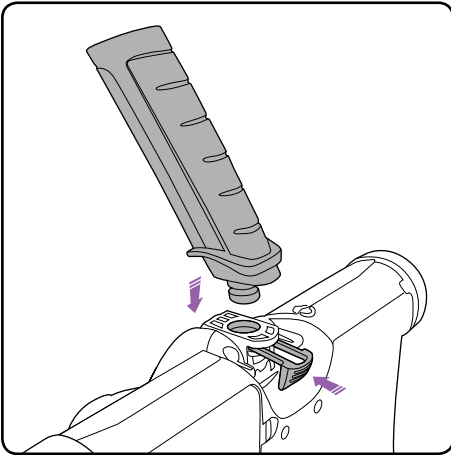

Place the lower handle into the socket.  
Push the locking clip back into place.  
Push handle forward.

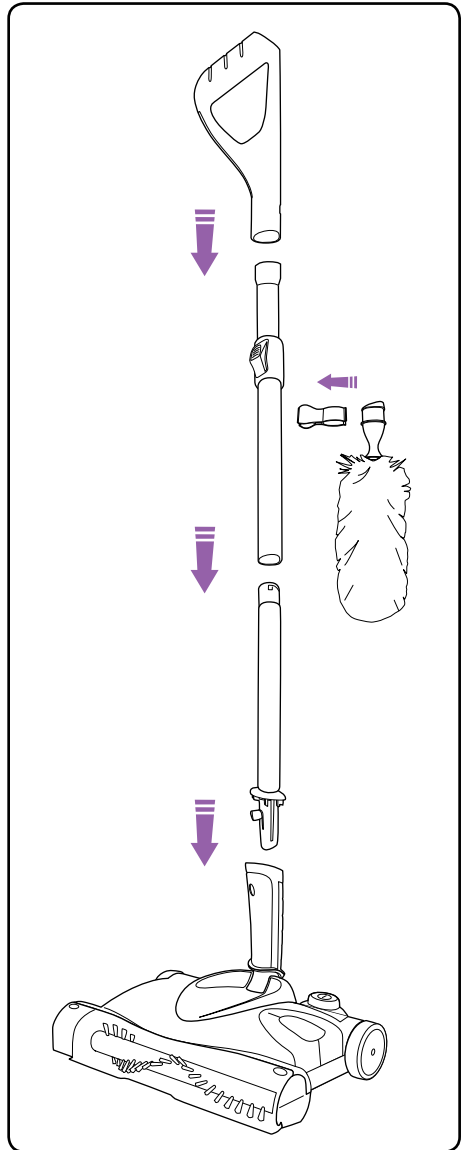

The three parts of the telescopic handle  
also click into place. The duster can be  
clipped onto the back of the handle.

## Operation

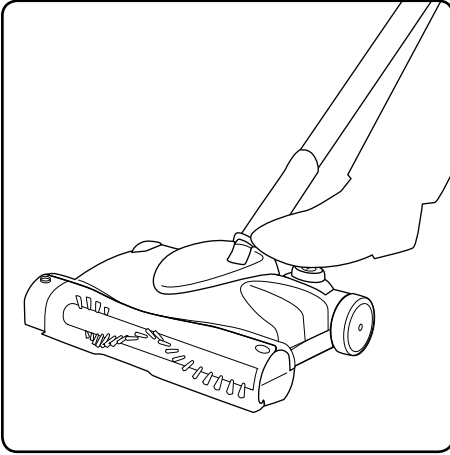

Pull back the handle and press the "on" button with your foot.

### Normal operation

Push flat over the floor.

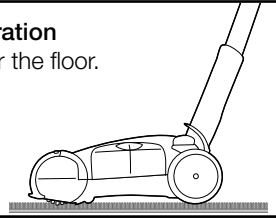

### Deeper cleaning

Lift the handle to lower the brush bar into the carpet.

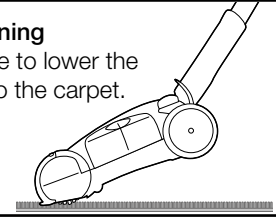

## Emptying the bin

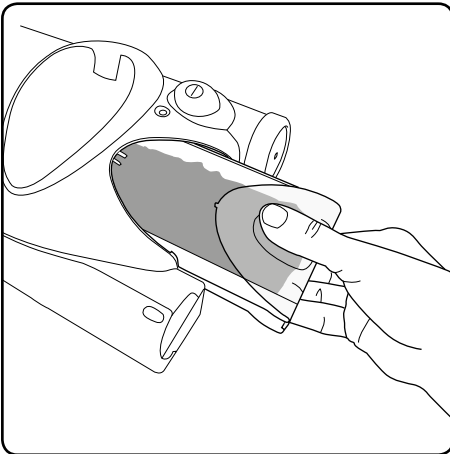

Remove the dust tray by pinching the window slightly, and pulling it out.

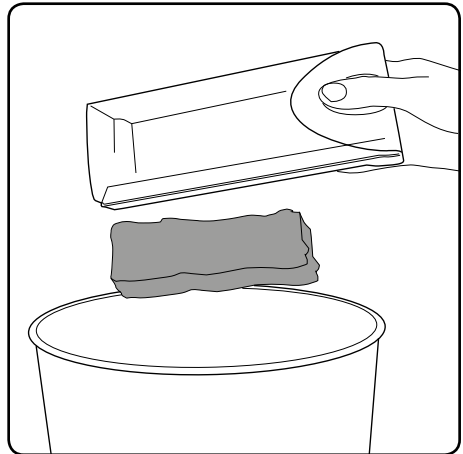

Tip the dirt into the bin. If you need to you can wipe the tray clean with a dry cloth.

## Removing telescopic handle and using duster

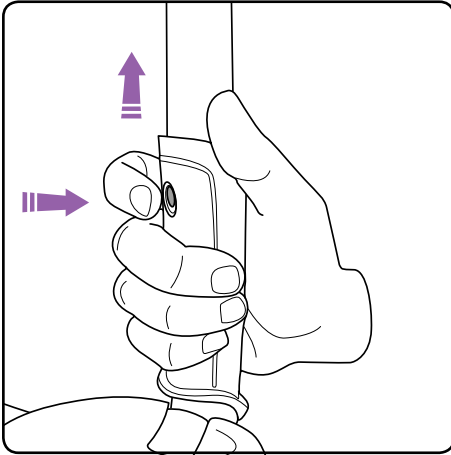

Remove the telescopic handle by pressing the button at the front of the lower handle and pulling the tube out.

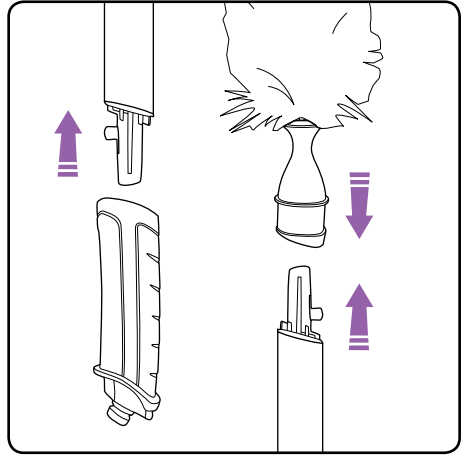

The telescopic handle can now be attached to the duster.

## Handheld use and stair cleaning

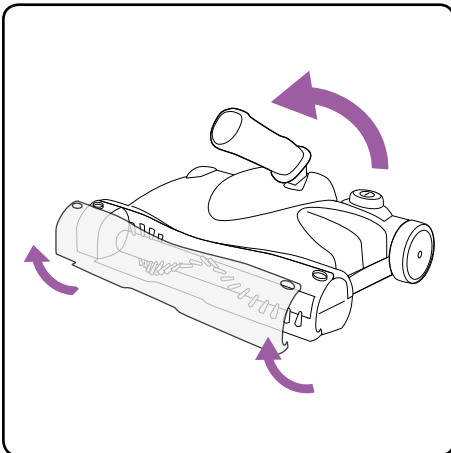

Remove the visor by unclipping the bottom outer edges at the same time then lifting off. Push lower handle fully forward.

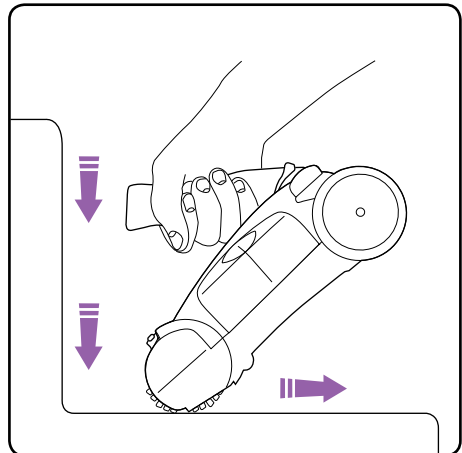

Use on stairs, starting at the top and front of each step then moving down and towards you.

## Recharging

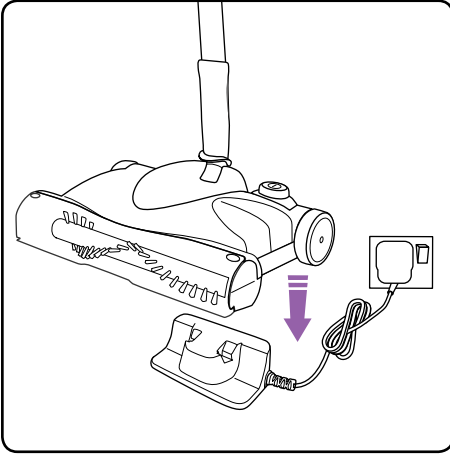

Plug in the **vecocharge** charge stand and lower the sweeper onto it so that the terminals connect at the back.

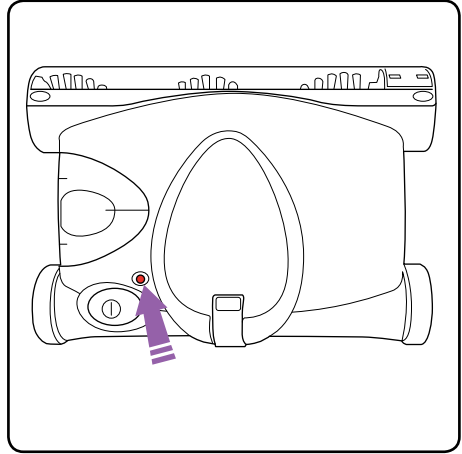

The light shows red while charging and green when fully charged. This will only take around 4 hours.

## Clearing the brush bar

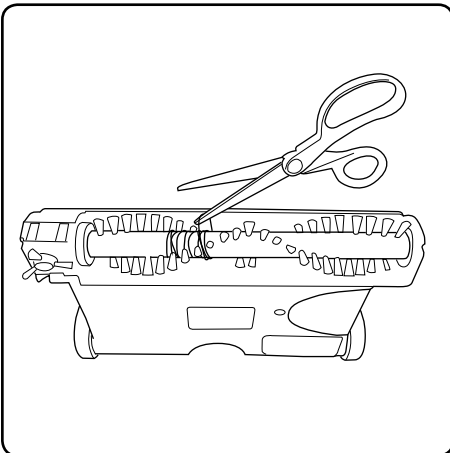

From time to time you may need to remove hair and thread from the brush bar. Take off visor and use a pair of scissors to remove the hair.

## Carrying

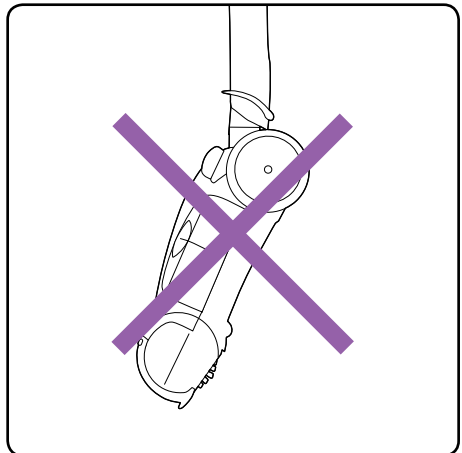

Try to avoid carrying the sweeper 'nose down' as you risk spilling dirt from the dust tray.



## Product Care

Your Gtech sweeper doesn't need much maintenance: empty the dust tray, remove hair and fibre from the brush bar and edge wheel and charge the battery. Wipe it with a dry cloth if it gets dirty, including in and around the bin. Never wash it with liquid or run it under a tap. Avoid cleaning over rug tassels or frayed carpets as this will tangle the brush bar. The battery, drive belt, brush bar and side brush are all replaceable items.

If you find you ever need to replace these items there is an FAQ section on our website at [www.gtech.co.uk](http://www.gtech.co.uk)

## ecocharge

The ecocharge stand has an efficient standby function to top up the battery when needed. If not being used the product can be left on the charging stand so it will always be fully charged until it is needed for use.

## Troubleshooting

Sweeper is not cleaning well	<ol style="list-style-type: none"><li>1. Empty the bin.</li><li>2. Remove any build-up of hair from brush bar and edge wheel.</li></ol>
Sweeper has stopped or won't work	<ol style="list-style-type: none"><li>1. Fully recharge for 4 hours.</li></ol>
If this doesn't solve your problem don't worry, we will help. Go to <a href="http://www.gtech.co.uk">www.gtech.co.uk</a> or call <b>01905 345 891</b>	

## WARRANTY – TERMS AND CONDITIONS

---

Grey Technology has provided this sweeper with a 12-month guarantee.

### **In Guarantee:**

Please retain your receipt as proof of purchase. In the rare and unfortunate event of your Gtech product being faulty, please accept our apologies and we will aim to remedy the problem as fast as possible once brought to our attention. However please be aware that due to Company Policy, Grey Technology can only repair or replace all or part of the product if proof of purchase is provided and the claim is made within 12 months of the purchase date.

If your product is within the 12 months warranty period you should either return this product with its receipt to the retailers where the product was purchased or if a simple part or advice is required ring the Gtech Helpline where we will be more than happy to assist.

**Note: Gtech cannot refund any monies if the product was brought from a third party.**

**Note: The battery is a consumable item and is not covered by this guarantee.**

We would like to remind our customers that the Gtech guarantee does not cover any unauthorised repairs and will be annulled:

- If the product has been damaged due to incorrect use or maintenance.
- If any part is modified or replaced or if it is used in any way that is not recommended by Gtech.
- If it is used with any parts not produced or not recommended by Gtech.
- If it is used for purposes other than those specified by Gtech.

If after reading the manual and following the instructions you are sure that the product is defective please call the **Gtech Helpline on 01905 345891**.

A Customer Service Advisor will be available to deal with any problems you have with our product. To assist them please be ready with the product, a detailed description of the problem, and your proof of purchase.

### **Out of Guarantee:**

If your Gtech product is over 12 months old and you need any parts or advice then please contact our Helpline. Parts will be sent out usually within 2 weeks of request.

Customer helpline **01905 345891**  
**support@greytechnology.co.uk**  
**www.gtech.co.uk**

## SW20 TECHNICAL SPECIFICATION

Unit operating cycle with full battery	up to 60 mins (dependent on floor surface)
Battery type	NiMH
Battery voltage	7.2V
Charging period for fully discharged battery	4 hours
Battery charger output	12V DC, 500mA
Battery charger model	GTECH-120050
Sound Level	75db (A)
Weight	1.6kg



The  symbol indicates that this product is covered by legislation for waste electrical and electronic products (EN2002/96/EC) When the sweeper has reached the end of its life, it and the NiMH battery it contains should not be disposed of with general household waste. The battery should be removed from the sweeper and both should then be disposed of properly at a recognised recycling facility.

Call your local council, civic amenity site, or recycling centre for information on the disposal and recycling of electrical products. Alternatively visit

**[www.recycle-more.co.uk](http://www.recycle-more.co.uk)** for advice on recycling and to find your nearest recycling facilities.



**WARNING: Only use the charger supplied with the product.**

Using another charger may damage the product and the battery and will invalidate your guarantee.

## FOR HOUSEHOLD USE ONLY



**Grey Technology Limited**

Cupola Court, Spetchley, Worcestershire WR5 1RL

email: [support@greytechnology.co.uk](mailto:support@greytechnology.co.uk)

telephone: 01905 345891

[www.gtech.co.uk](http://www.gtech.co.uk)