

**Lightweight
Hedge Trimmer**
Model Number: LHT50

OPERATING MANUAL
Original Instructions

GENERAL POWER TOOL SAFETY WARNINGS:



**IMPORTANT: READ ALL INSTRUCTIONS BEFORE USE.
RETAIN INSTRUCTIONS FOR FUTURE REFERENCE.**



WARNING: Read all safety warnings, instructions, illustrations, and specifications provided with this power tool. Failure to follow all instructions listed below may result in electric shock, fire, and/or serious injury. Save all warnings and instructions for future reference.



Do not use in rain or leave outdoors whilst raining.

The term “power tool” in the warnings refers to your mains-operated (corded) power tool or battery-operated (cordless) power tool.

Work area safety

- Keep the work area clean and well-lit. Cluttered or dark areas invite accidents.
- Do not operate power tools in explosive atmospheres, such as in the presence of flammable liquids, gases or dust. Power tools create sparks which may ignite the dust or fumes.
- Keep children and bystanders away while operating a power tool. Distractions can cause you to lose control.
- Only use in daylight or good artificial light.

Electrical safety

- Power tool plugs must match the outlet. Never modify the plug in any way. Do not use any adapter plugs with earthed (grounded) power tools. Unmodified plugs and matching outlets will reduce the risk of electric shock.
- Avoid body contact with earthed or grounded surfaces, such as pipes, radiators, ranges and refrigerators. There is an increased risk of electric shock if your body is earthed or grounded.
- Do not expose power tools to rain or wet conditions. Water entering a power tool will increase the risk of electric shock.
- Do not abuse the charger cord. Never use the charger cord for carrying, pulling or unplugging the power tool. Keep the charger cord away from heat, oil, sharp edges or moving parts. Damaged or entangled charger cords increase the risk of electric shock.
- When operating a power tool outdoors, use an extension cord suitable for outdoor use. Use of a cord suitable for outdoor use reduces the risk of electric shock.

- If operating a power tool in a damp location is unavoidable, use a residual current device (RCD) protected supply. Use of an RCD reduces the risk of electric shock.
- Do not handle the charger or hedge trimmer with wet hands.

Personal safety

- Stay alert, watch what you are doing and use common sense when operating a power tool. Do not use a power tool while you are tired or under the influence of drugs, alcohol or medication. A moment of inattention while operating power tools may result in serious personal injury.
- Use personal protective equipment. Always wear eye protection. Protective equipment such as a dust mask, non-skid safety shoes, hard hat or hearing protection used for appropriate conditions will reduce personal injuries.
- Prevent unintentional starting. Ensure the switch is in the ‘Off’ position before connecting to a power source and/or battery pack, picking up or carrying the tool. Carrying power tools with your finger on the switch or energising power tools that have the switch on invites accidents.
- Remove any adjusting key or wrench before turning the power tool on. A wrench or a key left attached to a rotating part of the power tool may result in personal injury.
- Do not overreach. Keep proper footing and balance at all times. This enables better control of the power tool in unexpected situations.
- Dress properly. Do not wear loose clothing or jewellery. Keep your hair and clothing away from moving parts. Loose clothes, jewellery, or long hair can be caught in moving parts.
- If devices are provided for the connection

of dust extraction and collection facilities, ensure these are connected and properly used. Use of dust collection can reduce dust-related hazards.

- Do not let familiarity gained from frequent use of tools allow you to become complacent and ignore tool safety principles. A careless action can cause severe injury within a fraction of a second.

Power tool use and care

- Do not force the power tool. Use the correct power tool for your application. The correct power tool will do the job better and safer at the rate for which it was designed.
- Do not use the power tool if the switch does not turn it on or off. Any power tool that cannot be controlled by the switch is dangerous and must be repaired.
- Disconnect the charger from the power source and/or remove the battery pack, if detachable, from the power tool before making any adjustments, changing accessories, or storing power tools. Such preventive safety measure reduces the risk of starting the power tool accidentally.
- Store idle power tools out of way of children and do not allow persons unfamiliar with the hedge trimmer or these instructions to operate the power tool. Power tools are dangerous in the hands of untrained users.
- Maintain power tools and accessories. Check for misalignment or binding of moving parts, breakage of parts and any other condition that may affect the power tool's operation. If damaged, have the hedge trimmer repaired before use. Many accidents are caused by poorly maintained power tools.
- Keep cutting tools sharp and clean. Properly maintained cutting tools with sharp cutting edges are less likely to bind and are easier to control.
- Use the power tool, accessories, and tool bits etc in accordance with these instructions, taking into account the working conditions and the work to be performed. Use of the power tool for operations different from those intended could result in a hazardous situation.
- Keep handles and grasping surfaces dry, clean and free from oil and grease. Slippery handles and grasping surfaces do not allow

for safe handling and control of the tool in unexpected situations.

Service

- Have your power tool serviced by a qualified repair person using only identical replacement parts. This will ensure that the safety of the power tool is maintained.
- Do not attempt to repair any damaged parts on the hedge trimmer unless you are qualified to do so.
- Only use replacement parts or accessories provided by or recommended by Gtech.

Hedge Trimmer safety warnings

- Keep all parts of the body away from the blade. Do not remove cut material, or hold material to be cut, when the blades are moving. Blades continue to move after the switch is turned off. A moment of inattention while operating the hedge trimmer may result in serious personal injury.
- Carry the hedge trimmer by the handle with the cutter blade stopped and taking care not to operate any power switch. Proper carrying of the hedge trimmer will decrease the risk of inadvertent starting and resultant personal injury from the blade.
- When transporting or storing the hedge trimmer, always fit the blade cover. Proper handling of the hedge trimmer will decrease the risk of personal injury from the blades.
- When clearing jammed material or servicing the unit, make sure all power switches are off and the power cord and/or battery pack is removed or disconnected. Unexpected actuation of the hedge trimmer while clearing jammed material or servicing may result in serious personal injury.
- Hold the hedge trimmer by insulated gripping surfaces only, because the cutter blade may contact hidden wiring or its own cord. Blades contacting a 'live' wire may make exposed metal parts of the hedge trimmer 'live' and could give the operator an electric shock.
- Keep all power cords and cables away from the cutting area. Power cords or cables may be hidden in hedges or bushes and can be accidentally cut by the blade.
- Do not use the hedge trimmer in bad weather conditions, especially when there is a risk of lightning. This decreases the risk of

being struck by lightning.

- Do not operate the hedge trimmer when the ambient temperature is above 35 degrees.
- Check the hedge and area where the hedge trimmer is being used for any objects, such as wire fences, that could damage or jam the trimmer blade.
- Do not overload the hedge trimmer. For safety, the hedge trimmer will automatically cut out if the motor becomes overloaded. If this occurs, wait a few seconds for the cut out to reset and then use lighter cuts to trim the hedge.
- Always disconnect the hedge trimmer from the removable battery: whenever the hedge trimmer is left unattended; before clearing a blockage; before checking, cleaning or working on the hedge trimmer; after striking a foreign object; whenever the hedge trimmer starts vibrating abnormally.
- Before use, and after any impact, always inspect the hedge trimmer for any damage. Do not use the hedge trimmer if any part is damaged or defective.
- Never operate the hedge trimmer while people, especially children, or pets are nearby.
- Always be sure of your footing on slopes or in slippery conditions. Do not over-reach or use this hedge trimmer on excessively steep slopes.
- Do not operate when barefoot or wearing open-toed shoes.
- Switch on the motor only when the hands and feet are away from the cutting means.
- Do not run with the hedge trimmer.
- Do not operate the hedge trimmer if it is incomplete or has unauthorised modifications.
- Read the instructions carefully. Be familiar with the controls and the correct use of the hedge trimmer.
- Never allow children or people unfamiliar with these instructions to use the hedge trimmer. Local regulations can restrict the age of the operator.

Extended-reach hedge trimmer safety warnings

- To reduce the risk of electrocution, never use the extended-reach hedge trimmer near any electrical power lines. Contact with or use near power lines may cause serious injury or

electric shock resulting in death.

- Always use two hands when operating the extended-reach hedge trimmer. Hold the extended-reach hedge trimmer with both hands to avoid loss of control.
- Always use head protection when operating the extended-reach hedge trimmer overhead. Falling debris can result in serious personal injury.
- Pay special attention to the hazards posed to third parties by the reach working radius. Always be aware of your surroundings and stay alert for possible hazards.

Battery safety:

- This product contains Li-ion batteries. Do not incinerate batteries or expose to high temperatures, as they may explode.
- Use only with the battery pack supplied.
- Do not attempt to use charger with any other product or to charge this product with any other charger.
- Recharge only with the charger specified by the manufacturer. A charger that is suitable for one type of battery pack may create a risk of injury and fire when used with another battery pack.
- Before charging, check the power supply and charger cables for signs of damage or ageing.
- Do not charge the battery when the surrounding air temperature or the battery pack is below 0°C or above 35°C.
- After heavy use or in high temperatures, the battery may become warm. Allow the product to cool for 30 minutes before charging.
- Leaks from battery cells can occur under extreme conditions. If the liquid gets on your skin, wash the area immediately with soap and water. If the liquid gets into your eyes, flush them immediately with cold water for a minimum of 10 minutes and seek urgent medical attention.
- Store the battery away from any liquids or chemicals that may damage the battery and cause a risk of fire.
- Store the battery in clean, dry conditions, within a recommended temperature range of 0 - 25°C
- Do not store the battery in areas of high temperature above 25°C. Do not store near a source of heat or where exposed to direct

sunlight.

- When the battery pack is not in use, keep it away from other metal objects, like paper clips, coins, keys, nails, screws or other small metal objects, that can make a connection from one terminal to another. Shorting the battery terminals together may cause burns or a fire.
- When you dispose of the appliance remove the battery and dispose of the battery safely in accordance with local regulations.

Maintenance and storage:

- Disconnect the hedge trimmer from the removable battery and ensure the motor and blade have stopped turning before: cleaning; clearing a blockage; checking or carrying out any maintenance on the hedge trimmer.
- Regularly check for misalignment or binding of moving parts, breakage of parts and any other condition that may affect the trimmers operations. If damaged have the hedge trimmer repaired or replaced.
- Check that the blade is clean and without damage. If the blade becomes worn, a replacement should be fitted before use.
- Wear protective gloves when handling or

cleaning the blade.

- Always ensure that the ventilation openings are kept clear of debris.
- Never modify the hedge trimmer in any way as this may increase the risk of personal injury.
- Keep the product and all accessories away from hot surfaces.
- When not in use, store the hedge trimmer out of the reach of children.

Intended use:

- Only use the hedge trimmer in the manner intended for cutting hedges, bushes, and shrubs, as described in these instructions.
- The hedge trimmer is not to be modified or operated differently to the manufacturer's specifications.
- Do not use with accessories other than those specified or recommended by Gtech.
- The hedge trimmer is not intended for commercial use.
- The hedge trimmer is intended for domestic use only.
- **WARNING! Observing these operating instructions is essential for safe assembly and use.**

Warning label descriptions



General hazard safety alert.



Read instruction manual before use



Wear eye protection when using this product.



Wear ear protection when using this product.



Measured sound power level: $L_{WA} = 87.5 \text{ dB(A)}$
 $K = 3 \text{ dB(A)}$

Guaranteed sound power level: 91 dB(A)

Note: Measured noise values determined according to 2000/14 EC (1.60m height, 1.0m distance away).



Do not use in rain or leave outdoors whilst raining.

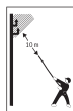

Risk of fatal injury due to electric shock!
Keep at least 10m away from electricity lines.



Keep hands away from blade.



Thank you for choosing Gtech

"Welcome to the Gtech family. I started Gtech to create sensible, easy to use products that do a great job, and hope you get many years of trouble-free performance from your new product."

Nick Grey – Inventor, owner of Gtech

What's in the box

- 1 Handle
- 2 Hedge trimmer head and blade
- 3 Blade cover
- 4 Battery
- 5 Battery charger
- 6 Safety harness
- 7 Tube

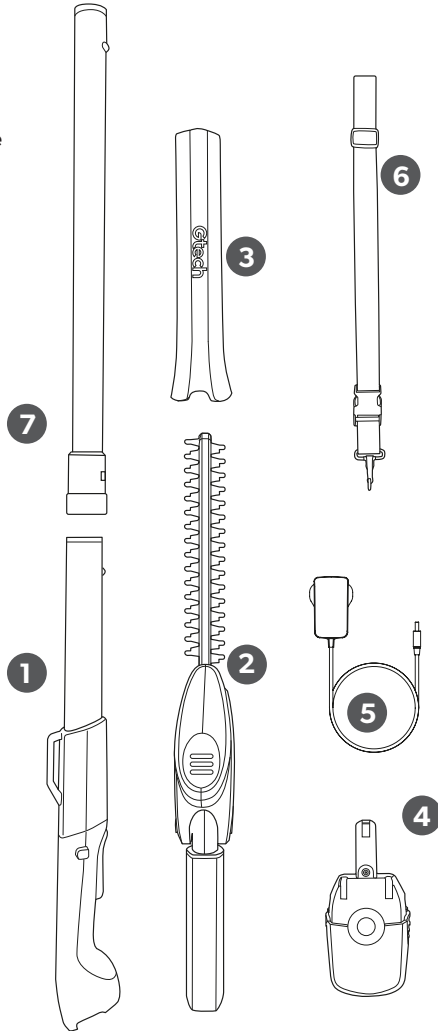

Assembly

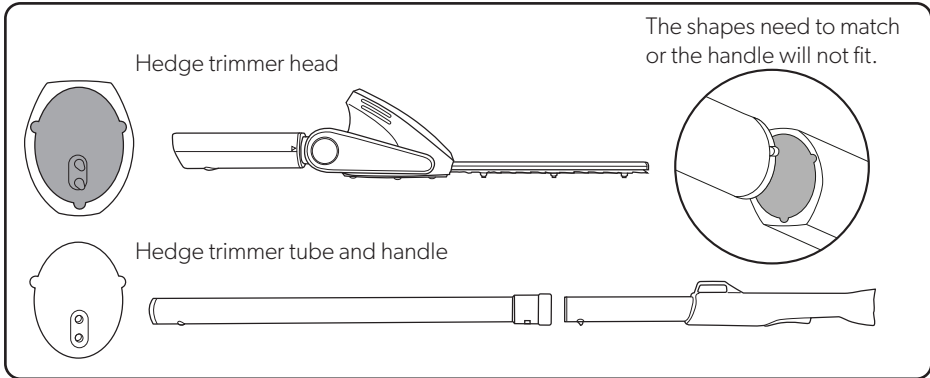

When inserting the tube into the hedge trimmer head, ensure the tube is the right way up. The shapes need to match or the handle will not fit.

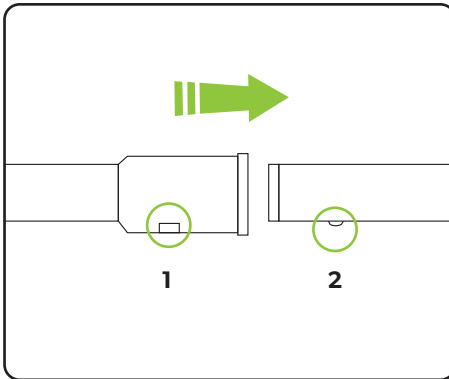

Assemble the handle to the tube. When the tube is fully inserted, the button (2) will pop up into the aperture (1).

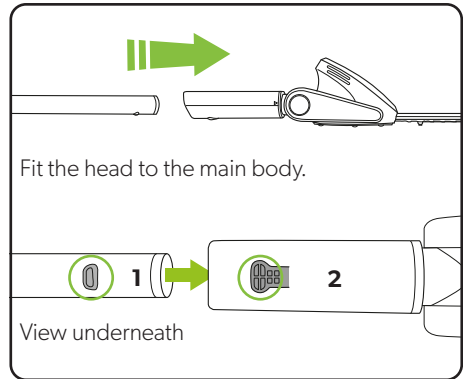

When the tube is fully inserted, the button (1) will lock securely into the head (2). To remove, press the button (2) and pull the tube.

Operation

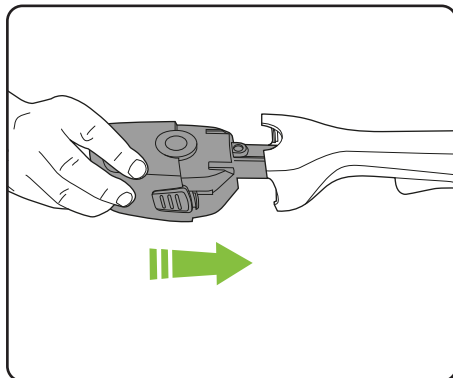

Insert the battery - it will click once fully inserted.

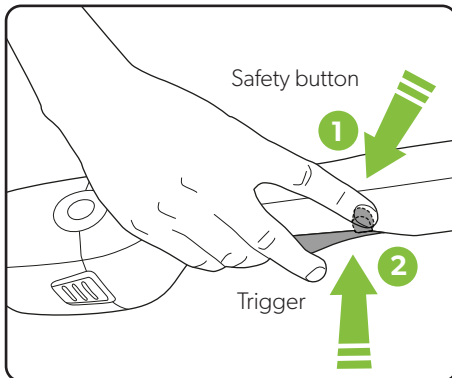

Push and hold the safety button, then press the trigger to operate.

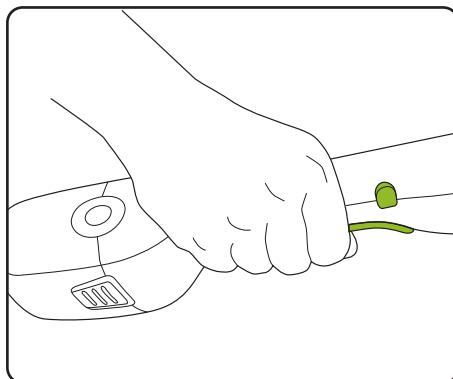

Keep holding the trigger but you can release the safety button. When you release the trigger the hedge trimmer will stop.

Rotating the hedge trimmer blade

WARNING: to reduce risk of personal injury, ensure the trimmer is switched off and the blade has stopped before adjusting the cutting head.

WARNING: ensure the cutting head is securely locked in position before starting the trimmer.

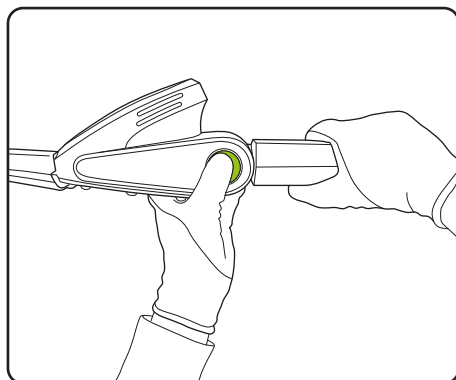

Remove the battery and ensure that the blade cover is on before continuing the next step. Depress the lever as shown. The head will now rotate freely.

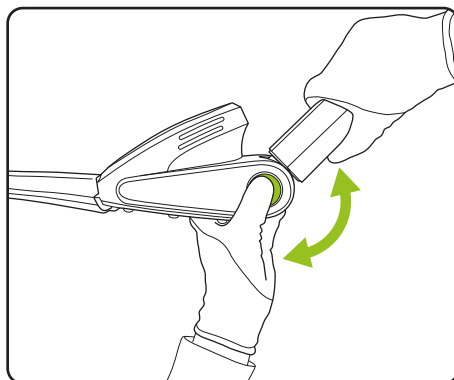

You can now rotate the head whilst pressing down on the lever. Release the lever and it will lock into place.

Safety harness

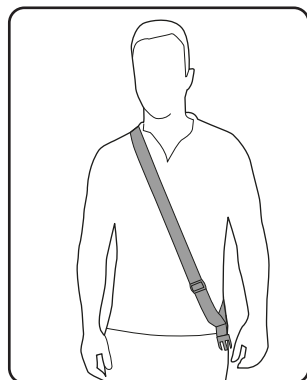

The harness is included as a safety feature for use with the hedge trimmer. The sling passes over your head and rests on your shoulder - use the sliding adjuster to ensure the harness fits you comfortably.

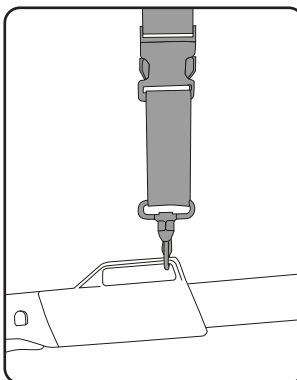

Attach the clip to the loop on the top of the handle. Then attach the clip to the harnesses.

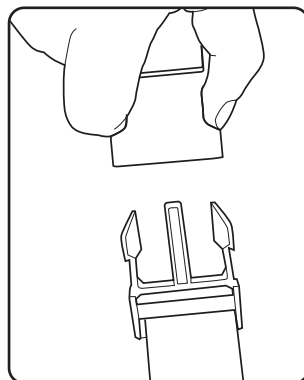

In an emergency situation, the harness clip can be released quickly.

Using your hedge trimmer

Hold the trimmer away from your body using both hands and stand on a solid and secure surface.

The double-edged blade allows you to cut with either a side-to-side or up and down motion.

When cutting, move slowly and steadily so that stems are fed directly into the blade. Cut the sides of the hedge first and then the top. To keep the sides of the hedge flat, cutting upwards with the growth is recommended.

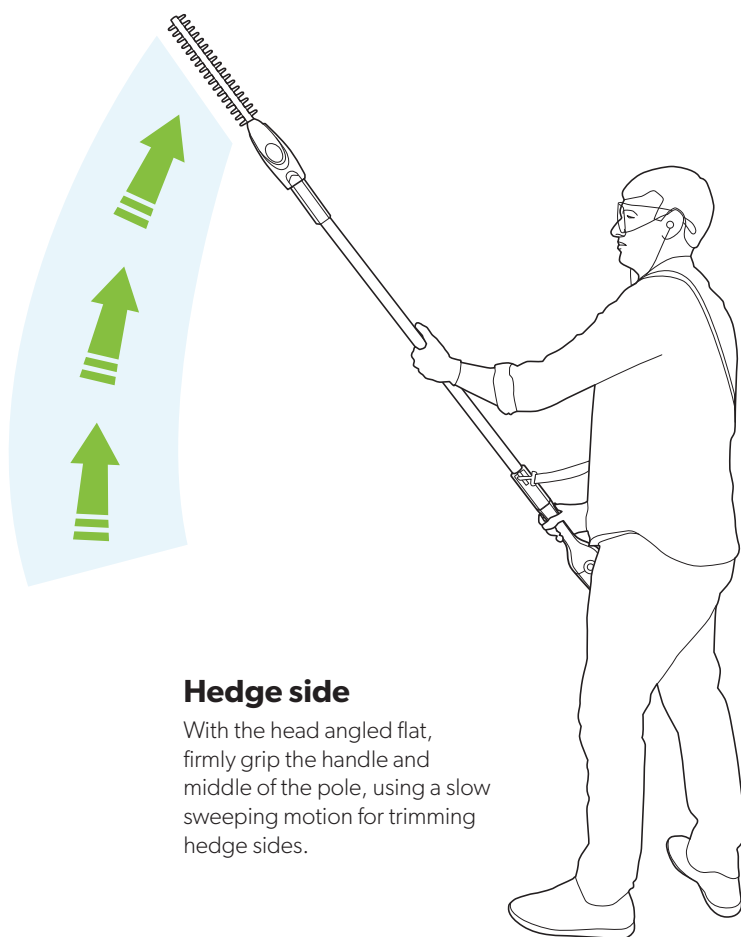

 **WARNING:** risk of electric shock. Pay attention to the position of overhead cables.

 **WARNING:** to reduce the risk of personal injury, always wear eye protection. Personal protective equipment such as sturdy gloves and non-slip shoes are recommended.

 **WARNING:** to reduce risk of injury from accidental start-up of the trimmer, always ensure that the protective blade guard is fitted when the trimmer is not in use, and when being transported, handled or stored.

 Pay attention to the hazard posed to third parties from the increased working area of the trimmer.

Hedge top

The head can be angled to help you trim the top of the hedge as you face it.

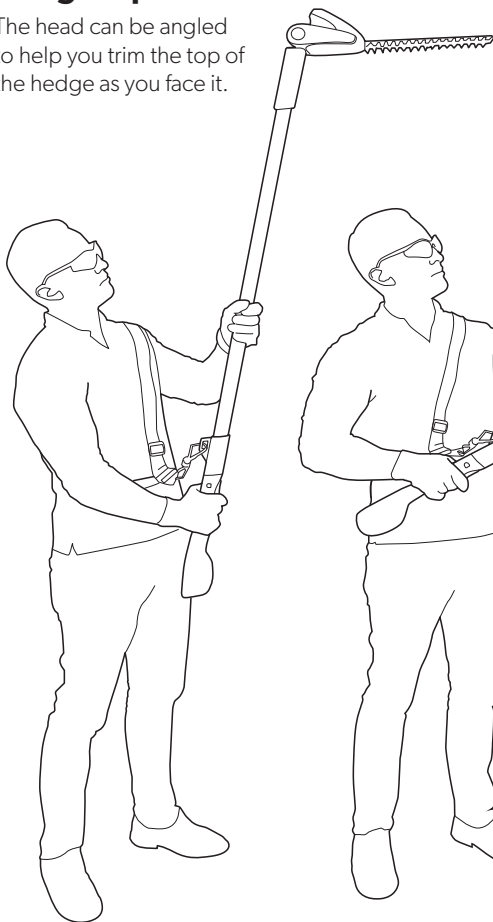

Upper hedge

For the higher parts of the hedge front, angle the head back.

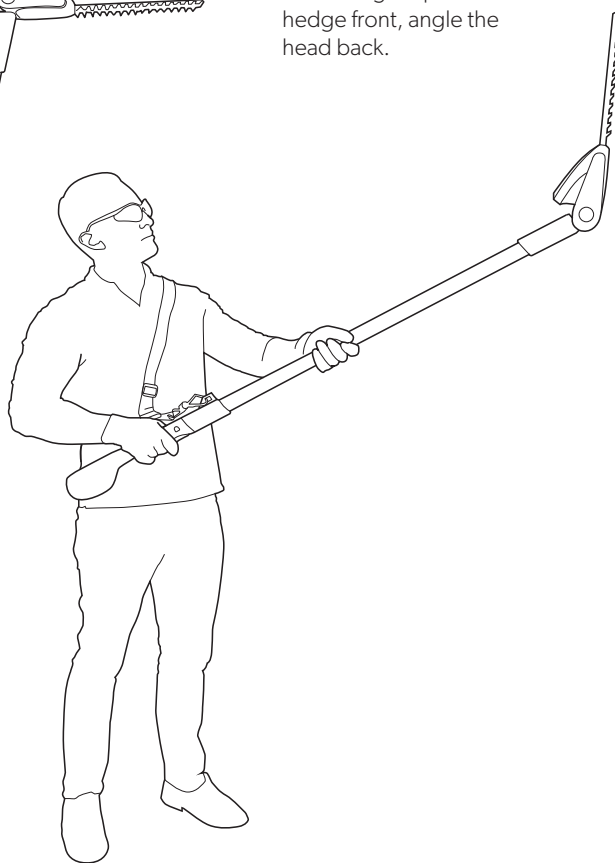

Checking battery charge status

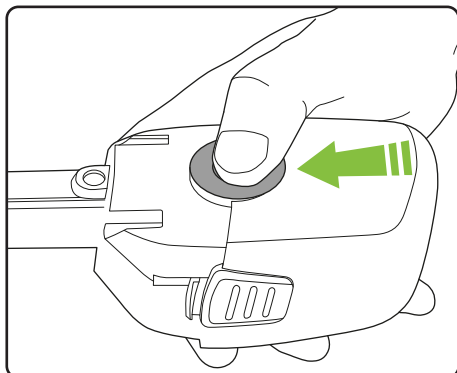

Press the button to check how much charge there is in the battery.

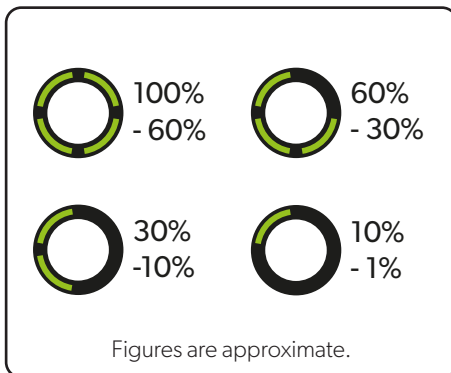

The number of lit LEDs shows the charge.

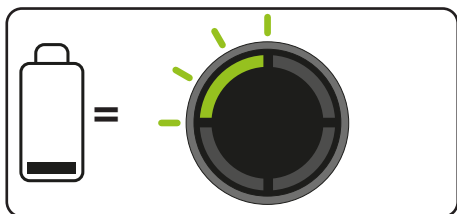

When there is no power left, the final LED will flash for 10 seconds then go out.

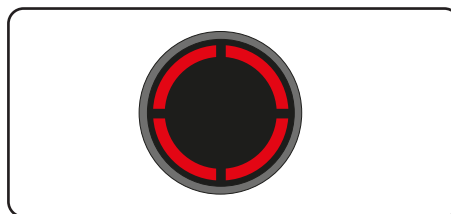

If product is jammed/overloaded, wait for the four LED lights to go out and restart.

Removing the battery for charging

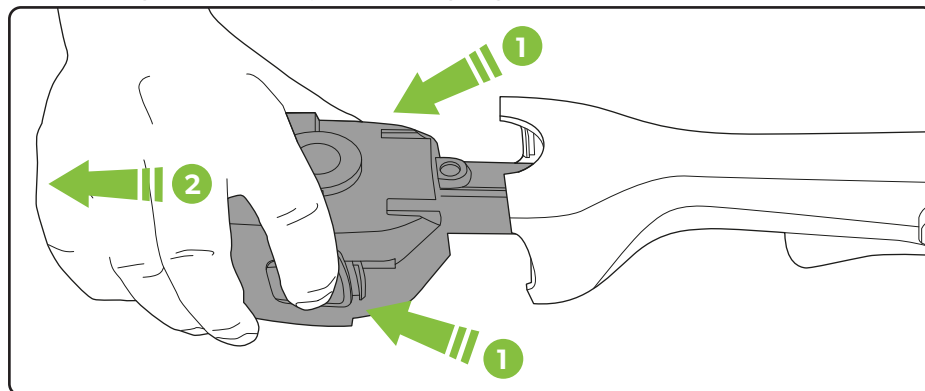

Press both buttons at the same time and pull to remove the battery.

Charging the battery

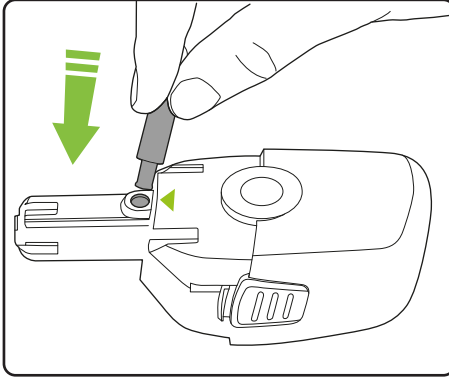

Connect the charger to the battery where indicated.

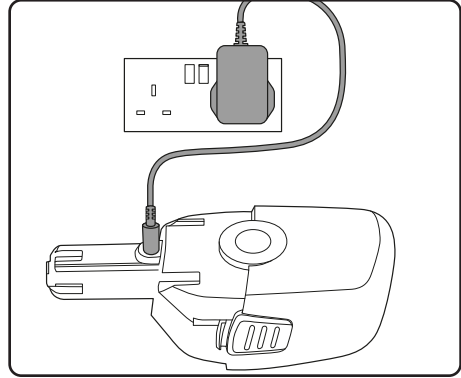

Plug the charger into an ordinary plug socket.

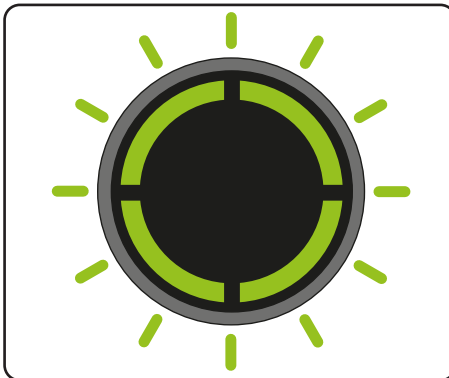

While charging, the LEDs will progressively pulse until all 4 are lit.

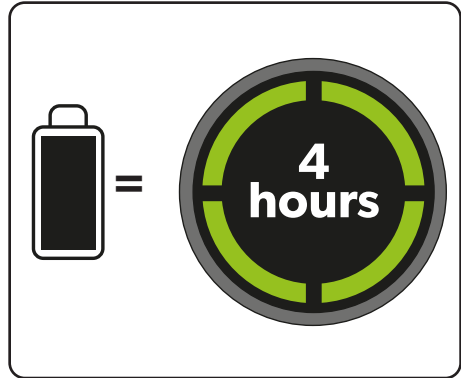

The battery can be charged from flat in 4 hours. The state-of-charge indicator will show 4 solid green lights when it is fully charged.

Product Care



Wear protective gloves when handling or cleaning the blade.



To reduce risk of injury, ensure that protective blade guard is fitted when the trimmer is not in use, and when being transported, handled or stored.

To ensure that your product gives you a long and reliable service, carry out the following maintenance regularly:



- Check for obvious defects, such as loose, dislodged, worn or damaged blades, loose fixings, and worn, damaged, or loose parts.
- Check that all covers and guards are correctly fitted and undamaged.
- Always clean the cutting blade after use and apply a lubricating oil or spray before storage.
- During longer cutting periods, it is recommended to lubricate the blade. This will improve cutting performance and maximise the run-time.
- Before use, check the condition of the cutting edges of the blade and check that the blade fixings are secure.
- Do not use water, solvents, or polishes to clean the trimmer. Wipe clean with a dry cloth.
- Do not use abrasive materials to clean the product, and do not immerse it in water.
- Store the hedge trimmer in a secure, dry place, out of reach of children. Do not expose it to moisture.
- To maintain optimum battery life store the battery in clean, dry conditions, within a recommended temperature range of 0 - 25°C. Do not store the battery in areas of high temperature above 25°C. Do not store near a source of heat or where exposed to direct sunlight.
- If the product will be stored for longer periods of time without use, for example during winter months, it is recommended to fully charge the battery before storage to help maintain its condition and life.

PLEASE NOTE: if the product needs to be repaired or replaced, only use replacement parts supplied by the manufacturer.

Spare parts can be purchased from Grey Technology Ltd:

tel: **08000 308794** www.gtech.co.uk

Troubleshooting

Trimmer fails to operate		<ol style="list-style-type: none"> 1. Recharge battery. 2. Check switch. It will click if operating correctly. 3. Blade is jammed.
Cutting blade will not cut		<ol style="list-style-type: none"> 1. Blade is either worn or damaged. 2. Replace blade.
Blade will not move		<ol style="list-style-type: none"> 1. Clean and lubricate blade. 2. Replace blade.
Cutting time has reduced		<ol style="list-style-type: none"> 1. Use a lighter cutting action and cut in several stages. 2. Fully discharge and recharge battery. 3. Clean and lubricate blade. 4. Replace blade.
Trimmer stops when cutting – 1 flashing green LED		<ol style="list-style-type: none"> 1. Battery is fully discharged. 2. Recharge the battery
Trimmer stops when cutting – 4 solid red LEDs		<ol style="list-style-type: none"> 1. The trimmer has jammed/overloaded. 2. Wait for automatic cut out to reset. 3. Check blade and remove any debris. 4. Use a lighter cutting action

Product support

If these initial tips do not solve your problem we please visit our support area where you can find troubleshooting help including online manuals, FAQs and how-to-videos, as well as genuine spares and replacement parts compatible with your product.

Visit: www.gtech.co.uk/support



Online



Live chat support



support@gtech.co.uk



How to Videos

Product recycling

Many of the electrical items that are thrown away can be repaired or recycled, saving natural resources and helping to protect the environment.

Gtech products are marked with the  symbol indicating they can be recycled, and are covered by legislation for Waste Electrical and Electronic Products (2012/19/EU)

When the product has reached the end of its life both it and the Li-Ion battery it contains should not be disposed of with general household waste. The battery should be removed from the product and both should be disposed of separately at a recognised recycling centre.

Recycling electrical products and batteries is free at your local recycling centre.

To find your nearest centre and discover how easy it is to recycle electrical products visit

www.recycle-more.co.uk

Alternatively contact your local council or civic amenity site.



HEDGE TRIMMER TECHNICAL SPECIFICATION

Blade cutting length	315mm
Blade cutting width	14mm
No load speed	1320min ⁻¹
Battery	18V Li-ion
Charging period	4 hours
Battery charger output	21.6V  0.5A 10.8W
Battery charger input	100-240V~50/60Hz
Measured sound power level, L _{WA}	L _{WA} =87.5 dB(A), uncertainty K=3dB(A)
Guaranteed sound power level, L _{WA}	91 dB(A)
Weight	2.1kg
Vibration (Vibration emission during actual use can differ from the declared value depending on how the trimmer is used.)	Front handle a _h = 1.33m/s ² Uncertainty k= 1.5 m/s ² Rear handle a _h = 1.21 m/s ² Uncertainty k= 1.5 m/s ²

WARRANTY – REGISTRATION

Visit www.gtech.co.uk/warrantyregistration to register your product to ensure that we have all the information required to provide you with quick and efficient support.

You will need your product's serial code.

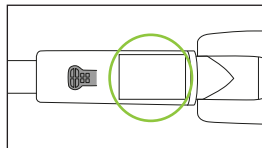

If you purchased directly from Gtech your details are already registered and your 2 year warranty will start automatically.

If you purchased from an authorised Gtech retailer, please register your warranty within 3 months and you will need to provide proof of purchase to support any claim against your warranty.

WARRANTY – TERMS AND CONDITIONS

If your product is within its warranty and has a fault that cannot be resolved from the troubleshooting section or online support, please do the following:

- Contact our Gtech Customer Care Helpline on UK: 08000 308 794, who will go through any troubleshooting with you to identify the fault.
- If your fault can be resolved by a replacement part, this will be sent to you free of charge.
- Following troubleshooting, if your product needs to be replaced, we will arrange collection of your faulty product for inspection, and delivery of a replacement product free of charge.

Your product is guaranteed against material or manufacturing faults for 2 years from the date of purchase (or the delivery date if this is later) subject to the following terms and conditions:

SUMMARY

The guarantee becomes effective at the date of purchase (or the date of delivery if this is later). If a product is repaired or replaced during the warranty period, the warranty period is not started again.

- You must provide proof of delivery/ purchase before any work can be carried out on the product. Without this proof, any work carried out will be chargeable. Please keep your receipt or delivery note.
- All work will be carried out by Gtech or its authorised agents.
- Any parts which are replaced will become the property of Gtech.
- The repair or replacement of your product is under guarantee and will not extend the period of guarantee.
- The guarantee provides benefits which are additional to and do not affect your statutory rights as a consumer.

WHAT ISN'T COVERED

Gtech does not guarantee the repair or replacement of a product as a result of:

- Normal wear and tear (e.g. blade, batteries).
- Accidental damage, faults caused by negligent use or lack of care and maintenance, misuse, neglect, careless operation or handling of the product which is not in accordance with operating manual.
- Blockages. Please refer to the operating manual for details of how to unblock your product.
- Use of the product for anything other than the normal domestic household purposes.
- Use of parts and accessories which are not Gtech genuine components.
- Faulty installation (except where installed by Gtech)
- If it is modified in any way.
- Repairs or alterations carried out by parties other than Gtech or its authorised agents.
- Purchasing your product from an unofficial third party (i.e not from Gtech or an official Gtech retailer).
- If you are in doubt as to what is covered by your guarantee, please call the Gtech Customer Care Helpline on UK: 08000 308 794

International orders are subject to a delivery charge for both faulty and non faulty products.

UKCA Declaration of Conformity

This declaration is issued under the sole responsibility of :

Grey Technology Ltd
Brindley Road
Warndon
Worcester
WR4 9FB
UK

Product : **Cordless Hedge Trimmer**
Model number : **LHT50**

The above product has been designed and manufactured to comply with the relevant UK regulations:

- Supply of Machinery (Safety) Regulations 2008
- Electromagnetic Compatibility Regulations 2016
- The Restriction of the Use of Certain Hazardous Substances in Electrical and Electronic Equipment Regulations 2012
- Noise Emission in the Environment by Equipment for use Outdoors Regulations 2001

With reference to standards:

EN 62841-1:2015
EN 62841--4-2:2019
EN IEC 55014-1:2021
EN IEC 55014-2:2021

Signed :

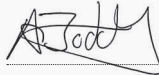

Date : 10/01/2023
Name : Andrew Boddy
Position : Technical Manager
Company : Grey Technology Ltd

EC Declaration of Conformity

We, manufacturer/importer

Grey Technology Ltd
Brindley Road
Warndon
Worcester
WR4 9FB

declare that the product

LHT50 Cordless Hedge Trimmer

complies with the essential health and safety requirements of the following directives:

- 2014/30/EU - EMC Directive.
- 2006/42/EC - Machinery Directive
- 2000/14/EC - Noise emission in the environment by equipment for use outdoors Directive.
 - Conformity assessment procedure as per ANNEX VI.
 - Measured Sound Power Level = 87.5 dB(A), uncertainty $K=3$ dB(A)
 - Declared Guaranteed Sound Power Level = 91 dB(A)
- 2011/65/EU - RoHS directive

Technical documentation holder: Grey Technology Ltd, WR4 9FB

Standards and technical specifications referred to :

EN 62841-1:2015
EN 62841-4-2:2019
EN IEC 55014-1:2021
EN IEC 55014-2:2021

Dokumentationsbevollmächtigter :
Authorized person for the compilation
of the technical documentation:

Andrew Boddy

Herstellerunterschrift/Datum:
Authorized Signature/Date/Place:

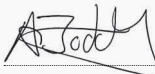

10/01/2023 Worcester, UK

Angaben zum Unterzeichner:
Title of Signatory:

Technical Manager



Grey Technology Limited

Brindley Road, Warndon, Worcester WR4 9FB, UK

email: support@gtech.co.uk

telephone: 08000 308 794

www.gtech.co.uk

240710 5360